

Product data sheet

Specifications



dual function relay, Harmony Timer Relays, 8A, 1C/O, 1s..100h, on delay, cadmium free, 24V DC or 24...240V AC DC

RE17RHMU

Product availability: Stock - Normally stocked in distribution facility

Main

Range of Product	Harmony Timer Relays
Discrete output type	Relay
Product or Component Type	Modular timing relay
Width	0.7 in (17.5 mm)
Device short name	RE17R
Time delay type	Interval
Time delay range	10...100 h 0.1...1 s 6...60 min 1...10 s 1...10 min 6...60 s 1...10 h
nominal output current	8 A

Complementary

Contacts type and composition	1 C/O
Contacts material	Cadmium free
Height	3.5 in (90 mm)
Depth	2.8 in (72 mm)
Control type	Selector switch front panel
[Us] rated supply voltage	24...240 V AC 50/60 Hz 24 V DC
Voltage range	0.85...1.1 Us
Supply frequency	50...60 Hz +/- 5 %
release of input voltage	10 V
Connections - terminals	Screw terminals, 1 x 0.5...1 x 3.3 mm ² AWG 20...AWG 12) solid without cable end Screw terminals, 2 x 0.5...2 x 2.5 mm ² AWG 20...AWG 14) solid without cable end Screw terminals, 1 x 0.2...1 x 2.5 mm ² AWG 24...AWG 14) flexible with cable end Screw terminals, 2 x 0.2...2 x 1.5 mm ² AWG 24...AWG 16) flexible with cable end
Tightening torque	5.3...8.9 lbf.in (0.6...1 N.m) IEC 60947-1
Housing material	Polycarbonate
Repeat accuracy	+/- 0.5 % IEC 61812-1
Temperature Drift	+/- 0.05 %/°C
Voltage drift	+/- 0.2 %/V

Price is "List Price" and may be subject to a trade discount – check with your local distributor or retailer for actual price.

Setting accuracy of time delay	+/- 10 % of full scale 25 °C IEC 61812-1
Time delay type	Interval - H- Interval relay Interval - Ht- Interval relay w/ pause/summation (Y1)
control signal pulse width	100 ms with load in parallel typical 30 ms typical
Insulation resistance	100 MOhm 500 V DC IEC 60664-1
Reset time	120 ms on de-energisation typical
On-load factor	100 %
Power consumption in VA	0...32 VA 240 V AC
Maximum power consumption in W	0.6 W 24 V DC
Minimum switching current	10 mA 5 V DC
Maximum switching current	8 A AC/DC
Maximum switching voltage	250 V AC
breaking capacity	2000 VA
operating frequency	10 Hz
Electrical durability	100000 cycles resistive 8 A 250 V AC
Mechanical durability	10000000 cycles
Dielectric strength	2.5 kV 1 mA/1 minute 50 Hz IEC 61812-1
[Uimp] rated impulse withstand voltage	5 kV 1.2/50 µs
power on delay	100 ms
Marking	CE
Creepage distance	4 kV/3 IEC 60664-1
Safety reliability data	B10d = 270000 MTTFd = 296.8 years
Mounting position	Any position in relation to normal vertical mounting plane
Mounting support	35 mm DIN rail conforming to IEC 60715
Local signalling	LED indicator on steady: relay energised, no timing in progress LED indicator 80 % ON and 20 % OFF flashing: timing in progress LED indicator 5 % ON and 95 % OFF pulsing: relay de-energised, no timing in progress (except function Di-D, Li-L)
Function available	H- Interval relay-1 C/O Ht- Interval relay w/ pause/summation (Y1)-1 C/O
Net Weight	0.15 lb(US) (0.07 kg)
Control Type	Without test button
Number of functions	2
Time delay type	H, Ht
Functionality	On-delay timing
Compatibility code	RE17

Environment

Immunity to microbreaks	20 ms
--------------------------------	-------

Standards	IEC 61000-6-4 IEC 61000-6-1 2006/95/EC IEC 61000-6-3 IEC 61812-1 2004/108/EC IEC 61000-6-2
Product Certifications	cULus CSA GL
Ambient Air Temperature for Storage	-22...140 °F (-30...60 °C)
Ambient Air Temperature for Operation	-4...140 °F (-20...60 °C)
IP degree of protection	IP20 IEC 60529 terminal block) IP40 IEC 60529 housing) IP50 IEC 60529 front panel)
Vibration resistance	20 m/s ² (f= 10...150 Hz) conforming to IEC 60068-2-6
Shock resistance	15 gn 11 ms IEC 60068-2-27
Relative Humidity	93 % without condensation IEC 60068-2-30
Electromagnetic compatibility	Electrostatic discharge immunity test 6 kV in contact) level 3 IEC 61000-4-2 Electrostatic discharge immunity test 8 kV in air) level 3 IEC 61000-4-2 Susceptibility to electromagnetic fields 10 V/m 80 MHz to 1 GHz) level 3 IEC 61000-4-3 Electrical fast transient/burst immunity test 1 kV capacitive connecting clip) level 3 IEC 61000-4-4 Electrical fast transient/burst immunity test 2 kV direct) level 3 IEC 61000-4-4 1.2/50 µs shock waves immunity test 1 kV differential mode) level 3 IEC 61000-4-5 1.2/50 µs shock waves immunity test 2 kV common mode) level 3 IEC 61000-4-5 Conducted RF disturbances 10 V 0.15...80 MHz) level 3 IEC 61000-4-6 Voltage dips and interruptions immunity test 0 % 1 cycle) IEC 61000-4-11 Voltage dips and interruptions immunity test 70 % 25/30 cycles) IEC 61000-4-11 Conducted and radiated emissions class B EN 55022

Ordering and shipping details

Category	US10CP222370
Discount Schedule	0CP2
GTIN	3606480552700
Returnability	Yes
Country of origin	ID

Packing Units

Unit Type of Package 1	PCE
Nbr. of units in pkg.	1
Package 1 Height	0.945 in (2.400 cm)
Package 1 Width	4.252 in (10.800 cm)
Package 1 Length	5.276 in (13.400 cm)
Package weight(Lbs)	2.751 oz (78.000 g)
Unit Type of Package 2	S02
Number of Units in Package 2	40
Package 2 Height	5.906 in (15.000 cm)
Package 2 Width	11.811 in (30.000 cm)
Package 2 Length	15.748 in (40.000 cm)
Package 2 Weight	8.135 lb(US) (3.690 kg)

Contractual warranty

Warranty (in months)

18



Environmental Data

Schneider Electric aims to achieve Net Zero status by 2050 through supply chain partnerships, lower impact materials, and circularity via our ongoing “Use Better, Use Longer, Use Again” campaign to extend product lifetimes and recyclability.

[Environmental Data explained >](#)

[How we assess product sustainability >](#)



Environmental footprint

Total lifecycle Carbon footprint	53 kg CO2 eq.
Carbon footprint of the manufacturing phase [A1 to A3]	2 kg CO2 eq.
Carbon footprint of the distribution phase [A4]	0.1 kg CO2 eq.
Carbon footprint of the installation phase [A5]	0 kg CO2 eq.
Carbon footprint of the use phase [B2, B3, B4, B6]	51 kg CO2 eq.
Carbon footprint of the end-of-life phase [C1 to C4]	0.2 kg CO2 eq.
Environmental Disclosure	Product Environmental Profile

Use Better



Materials and Substances

Packaging made with recycled cardboard	Yes
Packaging without single use plastic	Yes
SCIP Number	7bdc2711-0ad2-427c-8ece-532c5e9f09d7
EU RoHS Directive	Compliant By Exemption
REACH Regulation	Reference contains Substances of Very High Concern above the threshold
California proposition 65	WARNING: This product can expose you to chemicals including: Lead and lead compounds, which is known to the State of California to cause cancer and birth defects or other reproductive harm. For more information go to www.P65Warnings.ca.gov

Use Longer



Lifetime extension

Repair	No
--------	----

Use Again



Repack and remanufacture

Recyclability potential, in %	13
Circularity Profile	End of Life Information
Take-back	Nej

Dimensions Drawings

Width 17.5 mm

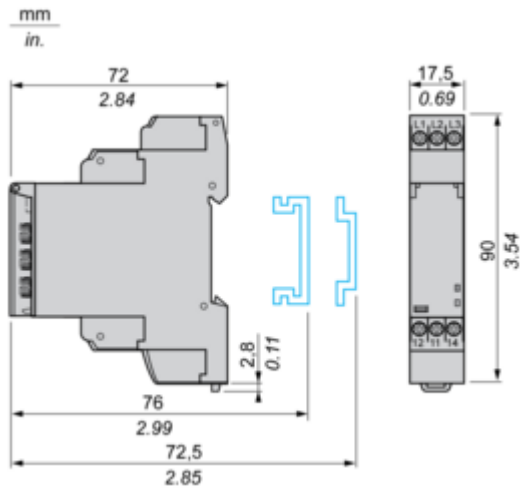

Connections and Schema

Internal Wiring Diagram

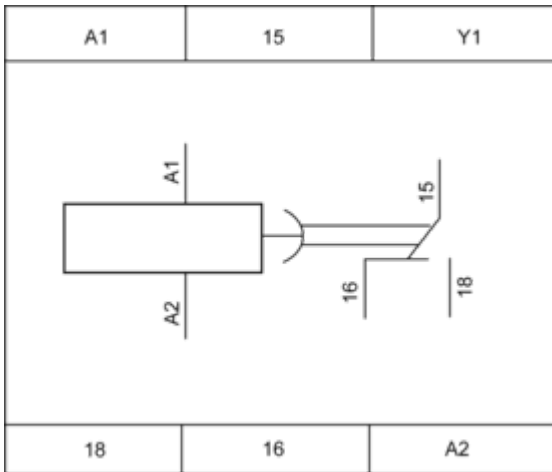

Wiring Diagram

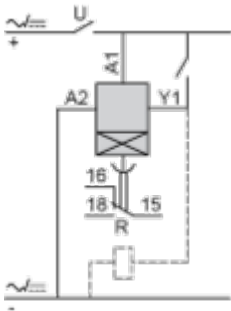

Technical Description

Function H : Interval Relay

Description

On energisation of the relay, timing period T starts and the output(s) R close(s). At the end of the timing period T, the output(s) R revert(s) to its/their initial state. The second output can be either timed or instantaneous.

Function: 1 Output



Function: 2 Outputs

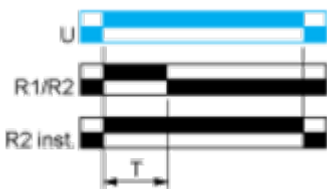

2 timed outputs (R1/R2) or 1 timed output (R1) and 1 instantaneous output (R2 inst.)

Function Ht: Interval Relay & With Pause / Summation Control

Description

On energisation of power supply, output(s) R close(s) and timing period T starts.

The timing can be interrupted / paused each time X1 energizes.

When the cumulative total of time periods elapsed reaches the pre-set value T, the output(s) R revert(s) to its/their initial state. Reenergization of X1 will also cause output(s) R close(s) if the time has elapsed and restart the same operation as described at the beginning.

Except for RE17*, RE22R2MMW, RENF22R2MMW, RE22R2MMU and RE22R2MJU, timing can be interrupted / paused each time Y1 energizes.

The second output (R2) can be either timed (when set to "TIMED" or instantaneous (when set to "INST").

Function: 1 Output

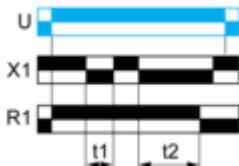

$T = t1 + t2 + \dots$

Function: 2 Outputs

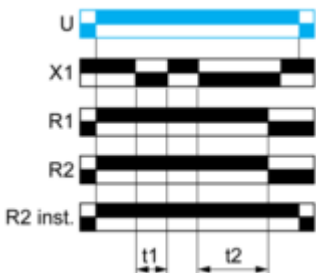

$T = t1 + t2 + \dots$

Function: 1 Output with Retrigger / Restart Control

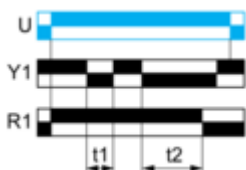



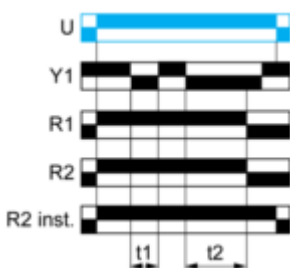

$T = t1 + t2 + \dots$

Function: 2 Outputs with Retrigger / Restart Control



$T = t1 + t2 + \dots$

Legend

-  Relay de-energised
-  Relay energised
-  Output open
-  Output closed

C	Control contact
G	Gate
R	Relay or solid state output
R1/R2	2 timed outputs
R2 inst.	The second output is instantaneous if the right position is selected
T	Timing period
Ta -	Adjustable On-delay
Tr -	Adjustable Off-delay
U	Supply

Technical Illustration

Dimensions

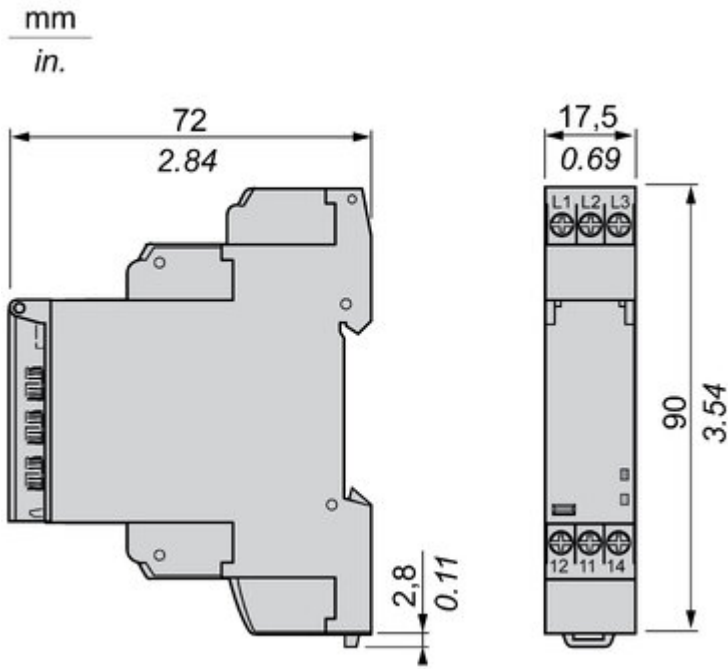

Offer Marketing Illustration

Product benefits / Features

Technical Benefits

Harmony Timer Relay

Flexible choice of screw or spring connection terminals for wiring.

One product reference covering 28 timing functions, 2 outputs, and a wide range of supply voltage 24...240 V AC/DC.

Dust and unintended human intervention avoided thanks to the IP50 lead-sealable settings protection cover.



A Dial-Pointer LED indicator that enhances ease of operation in difficult environments such as dusty or low-light conditions



Different mounting style to meet your preference:
DIN rail mount with product width; 17.5 mm/0.69 in.
22.5 mm/0.88 in.
Plug in mounting with socket

Offer Marketing Illustration

Product benefits / Features



Features

Harmony Timer Relay

-  "Diagnostic button" to check downstream circuit immediately, shorten the commission and troubleshooting time
-  Compatible with a wide range of applications including machines, buildings, water segments, and HVAC.
-  Wide range of time delay for adjustment: from 0.01 s to 999 hrs.
-  Compliant with IEC 60255-1 standard, and a wide array of product certifications such as UL, CE, CSA, EAC.
-  Unprecedented accuracy, predictive maintenance, and superior security.

Image of product / Alternate images

Alternative





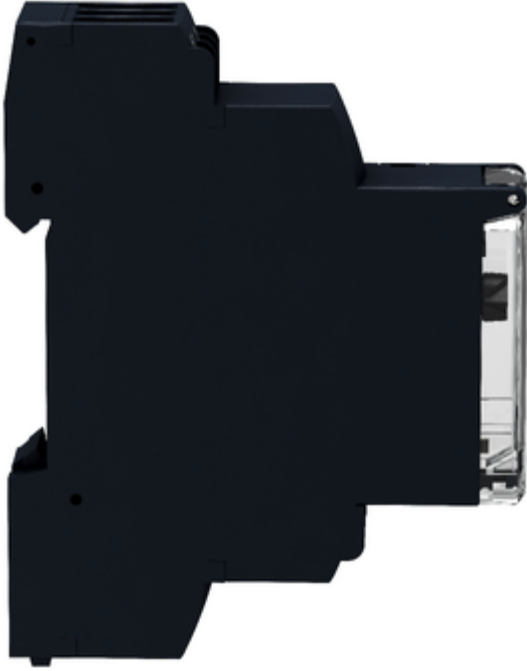

Image of product in real life situation

